

SERRANDA AVVOLGIBILE MICROFORATA P.115

Descrizione prodotto

Serranda monolamiera costruita con elementi microforati passo 115 mm agganciati tra loro, ottenuti dalla profilatura di nastri ciechi e forati in continuo durante la lavorazione. Fori diametro 4 mm e passo 6 mm.

Scorrimento verticale e ad avvolgimento superiore.

Zoccolo inferiore di altezza pari a 140 mm completo di maniglie e tamponamenti di battuta.

Ampia possibilità di personalizzazione con sistemi antivento, antirumore, inserimento di elementi per l'aerazione e finestrature.

Serranda conforme alla normativa UNI EN 13241-1 **CE**

Le serrande soggette all'azione del vento, ad esempio nel caso di installazione in facciata, devono essere conformi almeno alla classe 2 della EN 12424.

Caratteristiche e materiali

Materiale		Acciaio zincato	Alluminio	Acciaio Inox AISI 316
Spessore	[mm]	0,8	1,0	0,8
Peso manto	[kg/m ²]	9,50	4,00	9,50
Larghezza massima consigliata	[m]	13,50	5,00	13,50
Resistenza di spinta al vento Classe 2 ⁽¹⁾ Fino a Larghezza x Altezza		5000x2000	-	5000x2000
Percentuale di aerazione della facciata		24%	24%	24%
Luoghi di utilizzo		Garage – Negozi - Varie		

1. Ottenibile senza l'ausilio di staffe antistrappo.

Ingombri

Gli ingombri sono indicativi – per maggiori dettagli contattare il nostro Ufficio Tecnico.

Nel caso di funzionamento con albero rotante il minimo ingombro verticale è pari a 500 mm, dato dall'ingombro del motore e dei relativi supporti.

Nel caso di serranda in acciaio zincato spessore 0,8 mm o Inox AISI 316 spessore 0,8 mm con albero a molle o ottagonale D.70 fare riferimento alla tabella di seguito riportata; per valori degli ingombri relativi agli altri materiali contattare il nostro Ufficio Tecnico.

H Altezza	B - Diametro rotolo serranda avvolta																						
	Albero a molle										Albero ottagonale D. 70 con adattatore D. 180												
6000	385	385	385	410	410	410	410	410	-	-	-	-	-	-	-	385	-	-	-	-	-	-	-
5500	370	370	370	370	400	400	400	400	-	-	-	-	-	-	-	370	370	-	-	-	-	-	-
5000	355	355	355	355	390	390	390	390	390	-	-	-	-	-	-	355	355	-	-	-	-	-	-
4500	350	350	350	350	350	370	370	370	370	370	370	-	-	-	-	350	350	-	-	-	-	-	-
4000	340	340	340	340	340	340	360	360	360	360	360	360	400	-	340	340	340	-	-	-	-	-	-
3500	330	330	330	330	330	330	355	355	355	355	355	355	355	365	330	330	330	330	-	-	-	-	-
3000	320	320	320	320	320	320	345	345	345	345	345	345	345	345	320	320	320	320	320	-	-	-	-
2500	300	300	300	300	300	300	330	330	330	330	330	330	330	330	300	300	300	300	300	300	-	-	-
2000	290	290	290	290	290	290	315	315	315	315	315	315	315	315	290	290	290	290	290	290	290	290	-
	1500	2000	2500	3000	3500	4000	4500	5000	5500	6000	6500	6750	7000	7500	1500	2000	2500	3000	3500	4000	4500	5000	
	L – Larghezza																						



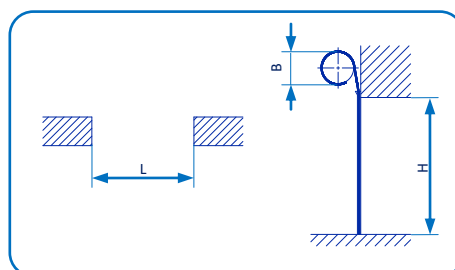
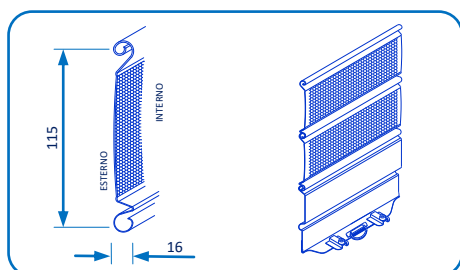

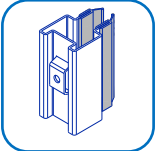
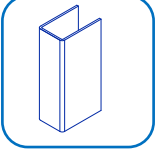
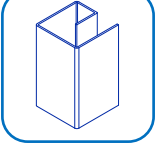

Nota: nel caso la fornitura preveda il montaggio di fermastecche, i valori del diametro del rotolo B riportati nella tabella vanno aumentati del 15% nel caso delle misure evidenziate in verde e del 10% nel caso delle misure evidenziate in giallo e rosso.

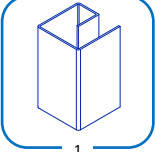
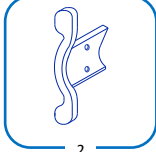
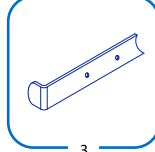
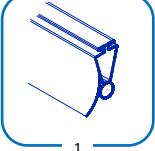
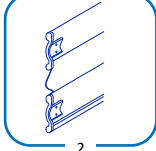
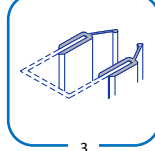
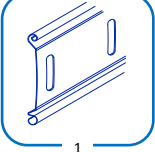
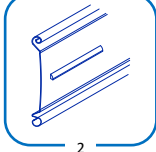
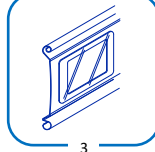
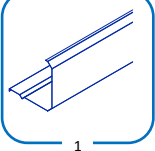
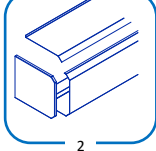
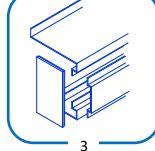
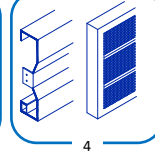
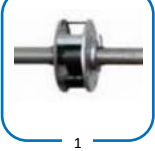

Guide di scorrimento

<p>Guida sagomata 60x50 in acciaio zincato spessore 2,0 mm Con guarnizioni per posa in luce e oltreluce per tutte le larghezze</p>	
<p>Guide a U in acciaio zincato spessore 1,5 mm - 30 x 22 x 30 per Larghezze fino a 2500 mm - 40 x 22 x 40 per Larghezze fino a 4400 mm - 40 x 25 x 40 per Larghezze fino a 4400 mm - 50 x 25 x 50 per Larghezze fino a 5600 mm - 70 x 27 x 70 per Larghezze fino a 7500 mm</p>	
<p>Guide a G in acciaio zincato spessore 2,0 mm - 60 x 60 – 80 x 60 – 80 x 80 – 100 x 80 - per serrande con diametro di avvolgimento superiore a 450 mm - per posa oltre luce fronte muro - per antivento e/o antistrappo</p>	

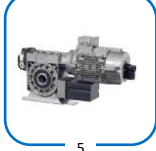
Accessori

Antivento e antistrappo	
<p>Kit per zone ventose, utilizzabile anche per necessità di maggiore garanzia antieffrazione, composto da:</p> <ol style="list-style-type: none"> 1. Guida a G 2. Fermastecche in nylon 3. Staffe antitempesta 	  
Antirumore	
<ol style="list-style-type: none"> 1. Gomma di battuta applicata su spiaggia 2. Fermastecche in nylon applicate agli elementi 3. Guarnizione in PVC per guide 	  
Aerazione e Finestrature	
<ol style="list-style-type: none"> 1. Elementi con fori a biscotto 50x12 mm (aerazione 50 cm²/mt) 2. Elementi con fori a tasca 85x5 mm (aerazione 20 cm²/mt) 3. Foro rettangolare 100x50 mm con o senza vetrino in plexiglass 	  
Coperture	
<ol style="list-style-type: none"> 1. Top frontale 2. Cassonetti interi formati da top frontale, top superiore e fondelli 3. Cassonetti con frontale asportabile per ispezione esterne 4. Velette in lamiera pressopiegata o costituita da elementi P.115 ciechi o microforati 	   
Funzionamenti	
<ol style="list-style-type: none"> 1. Funzionamento manuale con albero a molle Tubo tondo Ø 48 – 60 – 76 – 89 – 101 2. Funzionamento manuale con molla torsionale Tubo ottagonale zincato 70 – 102 3. Motore assiale per albero a molle Tubo tondo Ø 48 – 60 – 76 – 89 – 101 4. Motore tubolare con o senza manovra di soccorso Tubo ottagonale zincato 70 5. Motore laterale a presa diretta o rinvio a catena per alberi rotanti Ø 159 – 193 – 219 – 244 – 273 – 323 – 406 6. Motore Forza automatico Tubo ottagonale zincato 70 - 102 	     

Finiture

Verniciatura a fuoco RAL Standard					
1000	Beige verde	7004	Grigio segnale F14	8017	Marrone cioccolato
1001	Beige	7016	Grigio antracite	8019	Marrone grigio
1013	Bianco Perla	7021	Grigio scuro	8024	Marrone beige
1015	Avorio chiaro	7024	Grigio grafite	9001	Bianco crema
6005	Verde muschio	7040	Grigio finestra	9002	Bianco grigio
6009	Verde abete	7046	Grigio Tel. 2	9005	Nero profondo
6015	Oliva scuro	7047	Grigio Tel. 4	9010	Bianco puro
6019	Verde bianco	8004	Marrone rame	9011	Nero grafite
6023	Verde menta	8011	Marrone noce	9016	Bianco traffico
7000	Grigio vaio	8014	Marrone seppia		
7001	Grigio argento	8016	Marrone mogano		

Verniciatura a fuoco Speciali	
RAL 9006	Grigio Arsonsisi
Gialli / Rossi / Blu	Nero Raggrinzante Metallizzato
Bianco: Marmo (liscio) - Marmo antico (ruvido)	Nero / Marrone: Sabbia (ruvido)
Grigio: Marmo (liscio) - Marmo antico (ruvido)	Sabbia 900
Marrone: Marmo (liscio) - Marmo antico (ruvido)	Canna di Fucile
Verde: Marmo (liscio) - Marmo antico (ruvido)	Oro per esterni
Rosso: Marmo (liscio)	Marrone Martellato per esterni

Ossidazione per serrande in alluminio											
											
F01	F02	F03	F04	F05	F06	F07	F08	F09	F10	F11	F12

La gamma completa delle serrande

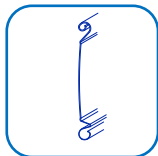

Cieca P.115



Microforata P.115

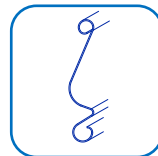

Cieca P.97



Microforata P.97

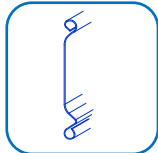

Cieca P.73



Microforata P.73

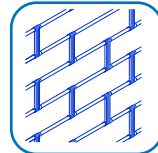

Tubolare P.120

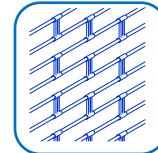

Tubolare P.95

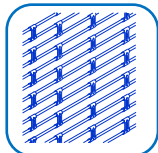

Tubolare P.60

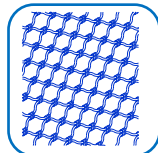

Tubonda

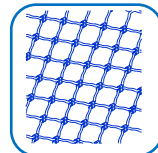

Tondino

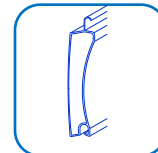

Coibentata DP.77



Coibentata DP.105

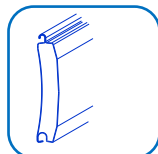

Coibentata DP.100

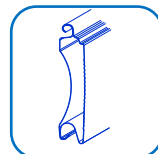

Coibentata DP.140

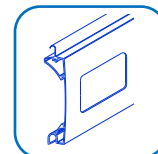

Finestrata



I contenuti delle schede tecniche sono indicativi e non impegnativi e in ogni caso saranno confermati dal nostro Ufficio Tecnico in fase di offerta o ordine.

Conegliano Serramenti s.r.l. può apportare modifiche, fermo restando le caratteristiche principali

Conegliano Serramenti S.r.l

Via Campolongo 1/E Loc.Ramera Z.I. / 31010 Mareno di Piave – Treviso - Italy

Tel: +39 0438.4985 Fax: +39 0438.498540 / Web site: www.coneglianoserramenti.it www.forza-motion.com

P.I. e C.F.: 00532460268- N.Reg.Imp.di TV 8758 / Capitale Sociale i.v.: € 78.000,00 – Capitale esistente al 31.12.15 € 78.000,00